



# Andover Continuum™ xP Expansion I/O Family

The Andover Continuum xP Expansion I/O Family provides a convenient and cost-effective means to add additional inputs, outputs, or a local display to the Andover Infinet™ II and BACnet™ family of distributed controllers.

Up to two modules plus a local display can be powered directly from any of the following controllers in the Infinet II (i2) or BACnet (b3) families: i2/b3 920, i2/b3 810, i2/b3 814, i2/b3 850, i2/b3 851, or i2/b3 853. The bCX1 Controller/Router models can also be used to connect xP Expansion Modules (and Display) and are the only controllers that support the xPBA4 and xPBD4 module types. No external power supply is required to power the Module(s). Consult the xP Modules and Local Display Modules User Guide for valid configurations.

- Powerful, Flexible System Allows for Simple Addition of a Few I/O Points
- Individual Overrides of All Digital Outputs
- Universal Inputs Provide the Most Flexibility, Including a Single High Speed Counter Input
- Individual Overrides and Potentiometers for All Analog Outputs
- Full Function Manual Overrides Provide Status Feedback
- 4-Line, 16-character Display with Keypad Provides Simple and Convenient Operator Interface
- Locally Mounted or Remote Mount of Modules and Display
- Module Power Supplied by the Controller, Reducing Installation Time and Cost

- **xPDI8** – The xPDI8 module allows the addition of 8 Digital Inputs in a small enclosure.
- **xPUI4** – The xPUI4 module allows the addition of 4 Universal Inputs. Each can be configured independently based on your needs for Digital, Temperature, Motion Sensor, or Pulse Counter Inputs, etc., providing built-in flexibility for your different application requirements.
- **xPAO2/xPAO4** – Both the xPAO2 (2 Analog Outputs) and the xPAO4 (4 Analog Outputs) allow the addition of Analog Outputs. Each output has individual manual override switches to select Manual, Off, or Auto for program control. When in Manual mode, each output also has a potentiometer to allow control of the override point.
- **xPDO2/xPDO4** – Both the xPDO2 (2 Digital Outputs) and the xPDO4 (4 Digital Outputs) allow the addition of Digital Outputs. Each output has individual manual override switches to select On, Off, or Auto for program control.
- **xPBA4/xPBD4** – Both the xPBA4 and the xPBD4 combine the functions of two xP Expansion modules. Similar to the xPUI4, both allow the addition of 4 Universal Inputs. The xPBA4 allows the addition of 4 Analog Outputs (like the xPAO4), and the xPBD4 allows for the addition of 4 Digital Outputs (like the xPDO4). (Note: The xPBA4 and xPBD4 Expansion Modules can only be connected to the bCX1 Controller/Routers and ACX Series Access Controllers.)

## LOCAL DISPLAY

The local display with keypad (xP Display) allows for the addition of a fully programmable local display module that can be mounted within 10 feet (3 meters) of the controller. Connected via a ribbon cable, the xP Display easily allows the Operator Interface to be mounted on the door of an enclosure or on a wall below or next to the controller.

# xP Expansion I/O Family

**xPDI8**

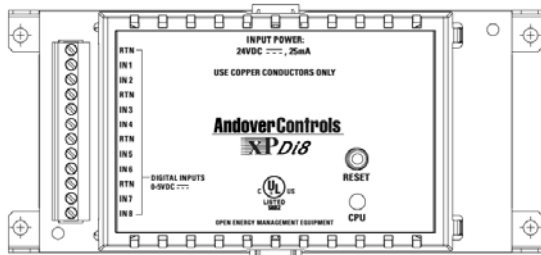

**INPUTS**

- 1 RTN
  - 2 IN 1
  - 3 IN 2
  - 4 RTN
  - 5 IN 3
  - 6 IN 4
  - 7 RTN
  - 8 IN 5
  - 9 IN 6
  - 10 RTN
  - 11 IN 7
  - 12 IN 8
- DIGITAL INPUTS  
0-5VDC ---

**xPUI4**

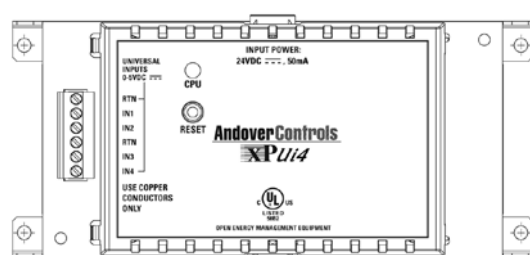

**INPUTS**

- 1 RTN
  - 2 IN 1
  - 3 IN 2
  - 4 RTN
  - 5 IN 3
  - 6 IN 4
- UNIVERSAL INPUTS  
0-5VDC ---

**xPAO4**

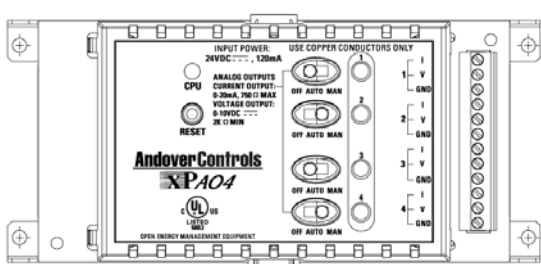

**OUTPUTS**

- 1 V 12
- 1 V 11
- GND 10
- 2 V 9
- 2 V 8
- GND 7
- 3 V 6
- 3 V 5
- GND 4
- 4 V 3
- 4 V 2
- GND 1

**xPAO2**

**OUTPUTS**

- 1 V 12
- 1 V 11
- GND 10
- 2 V 9
- 2 V 8
- GND 7

Similar to xPAO4; however only the first 2 outputs are populated.

**xPDO4**

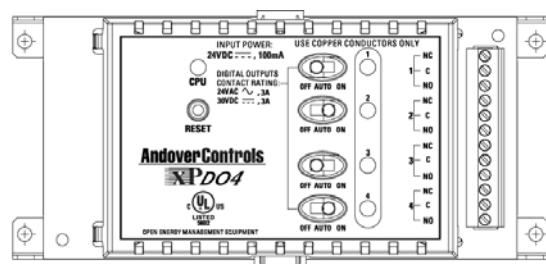

**OUTPUTS**

- 1 NC 12
- 1 C 11
- 1 NO 10
- 2 NC 9
- 2 C 8
- 2 NO 7
- 3 NC 6
- 3 C 5
- 3 NO 4
- 4 NC 3
- 4 C 2
- 4 NO 1

**xPDO2**

**OUTPUTS**

- 1 NC 12
- 1 C 11
- 1 NO 10
- 2 C 8
- 2 NO 7

Similar to xPDO4; however only the first 2 outputs are populated.

**xPBA4**

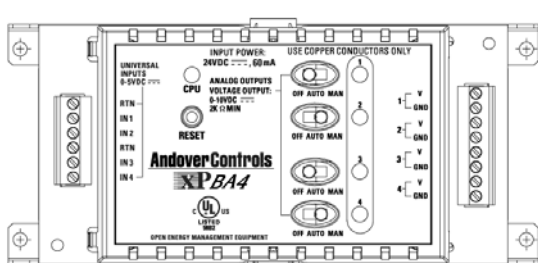

**INPUTS**

- UNIVERSAL INPUTS  
0-5VDC ---
- 1 RTN
- 2 IN 1
- 3 IN 2
- 4 RTN
- 5 IN 3
- 6 IN 4

**OUTPUTS**

- 1 V 14
- GND 13
- 2 V 12
- GND 11
- 3 V 10
- GND 9
- 4 V 8
- GND 7

**xPBD4**

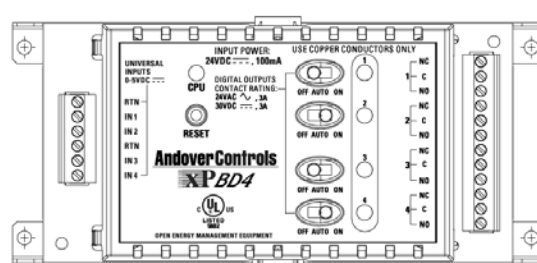

**INPUTS**

- UNIVERSAL INPUTS  
0-5VDC ---
- 1 RTN
- 2 IN 1
- 3 IN 2
- 4 RTN
- 5 IN 3
- 6 IN 4

**OUTPUTS**

- 1 NC 18
- 1 C 17
- 1 NO 16
- 2 NC 15
- 2 C 14
- 2 NO 13
- 3 NC 12
- 3 C 11
- 3 NO 10
- 4 NC 9
- 4 C 8
- 4 NO 7

# SPECIFICATIONS

## xP Expansion I/O Family

### ELECTRICAL

#### Power

Up to two I/O module and an xP-Display may be connected to a controller. All controllers provide a total of 180 mA of power, the bCX1 controller/router has 400 mA of power, for the modules. Each module's power consumption is listed below. Reference installation sheet for valid combinations

### MECHANICAL

#### Operating Environment

32°–120°F (0–49°C), 10–95% RH (non-condensing)

#### Size

Module: 3.21" H x 7.10" W x 1.60" D (82H x 180 W x 41 D) mm

Display: 7.25" H x 5.00" W x 1.65" D (184H x 127 W x 42 D) mm

#### Weight

Module: 0.48 lb (0.22 kg)  
Display: 1lb (0.45 kg)

#### Enclosure Type

Modules: UL Open class, IP 10. Flammability rating of UL94-5V

Display: IP54

### COMMUNICATIONS

#### Communications Interface

Through built-in Expansion Port on controller

### CONNECTIONS

#### Fixed Terminal Connectors

Reference specific module on previous page for terminal point assignments

#### Input (top)

6-pin shrouded connector

#### Output (bottom)

6-pin shrouded connector

### USER LEDS/SWITCHES

#### Status Indicator LEDS

CPU Module is Active

#### Switches

RESET

### GENERAL

#### xP Modules

Consult the xP Module Installation Guide for the maximum number of inputs/outputs allowed on each controller.

### CABLE OPTIONS

#### xP-Mod-Cable-3

3-foot (~1m) ribbon cable terminated

#### xP-Mod-Cable-10

10-foot (~3m) ribbon cable terminated

### AGENCY LISTINGS

UL/CUL 916, FCC CFR 47 Part 15, ICES-003, EN55022, AS/NZS 3548, Class A, CE

### xPDI8 (DIGITAL INPUTS)

#### Points

8 Digital Inputs

#### Power Consumption

25 mA

#### Voltage

0-5 VDC, or contact closure

#### Input Impedance

10K ohm ref to +5VDC

#### Frequency

140Hz, 50% duty cycling, 3.57 ms pulse width min.

#### Overvoltage Protection

24 VAC/DC +/- 1500 V transients

### xPUI4/xPBA4/xPBD4 (UNIVERSAL INPUTS)

#### Points

4 Universal Inputs

#### Power Consumption

50 mA (xPUI4)  
60 mA (xPBA4)  
125 mA (xPBD4)

#### Voltage

0-5.115 VDC

#### Input Impedance

10K ohm ref to +5VDC

#### Frequency

4Hz, 50% duty cycling, 125 ms pulse width min. (Inputs 1-3)  
140Hz, 50% duty cycling, 3.57 ms pulse width min. (Input 4)

#### Overvoltage Protection

24 VAC/DC +/- 1500 V transients

### xPAO2/xPAO4/xPBA4 (ANALOG OUTPUTS)

#### Points

2 Analog Outputs (xPAO2)  
4 Analog Outputs (xPAO4, xPBA4)

#### Power Consumption

80 mA (xPAO2)  
120 mA (xPAO4)  
60 mA (xPBA4)

#### Output Rating

0-10 VDC  
4-20mA per channel (xPAO2, xPAO4)

#### Output Resolution

0.1V for 0-10V  
0.1mA for 4-20mA (xPAO2, xPAO4)

#### Overrides

yes – per output point. Software feedback of the switch position is provided, for display and alarming

#### Potentiometer

yes – per output point

### xPDO2/xPDO4/xPBD4 (DIGITAL OUTPUTS)

#### Points

2 Digital Outputs (xPDO2)  
4 Digital Outputs (xPDO4, xPBD4)

#### Type

2 or 4 single pole single throw (SPST) Form C relays

#### Power Consumption

60 mA (xPDO2)  
100 mA (xPDO4)  
125 mA (xPBD4)

#### Output Rating

Maximum 3A, 24 VAC/VDC, +/- 1500 V transients (tested according to EN61000-4-4)

#### Output Accuracy

0.1 sec for pulse width modulation

#### Output Overrides

Each Output is equipped with a manual override switch. Software feedback of the switch position is provided, for display and alarming

(xP-Display information on back page)

## PROGRAMMING

Programming with the Expansion Modules points are treated in the same manner as the built-in I/O points on the controller. Once the points have been configured, they are available for graphics, Plain English™ programming, or for displaying data on the display.

## INSTALLATION

Modules can be connected to the bottom of the controller with the built-in expansion port connector or they may be connected remotely via a 3-foot (~1 m) or 10-foot (~3m) ribbon cable. A total of 10 feet of cable may be used for all Expansion Modules. Mounting and securing of the xP modules is provided through four mounting holes in the base plate.

**xP MODULE DIMENSIONAL DRAWING**

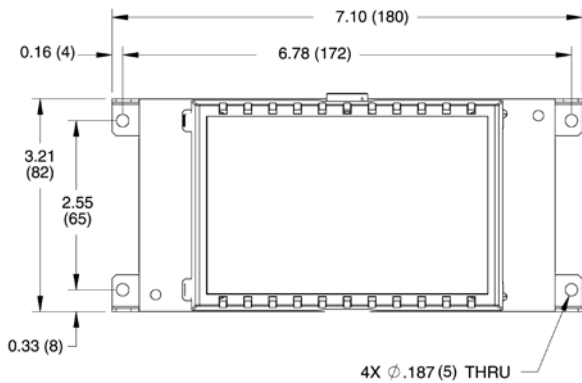

**xP DISPLAY DIMENSIONAL DRAWING**

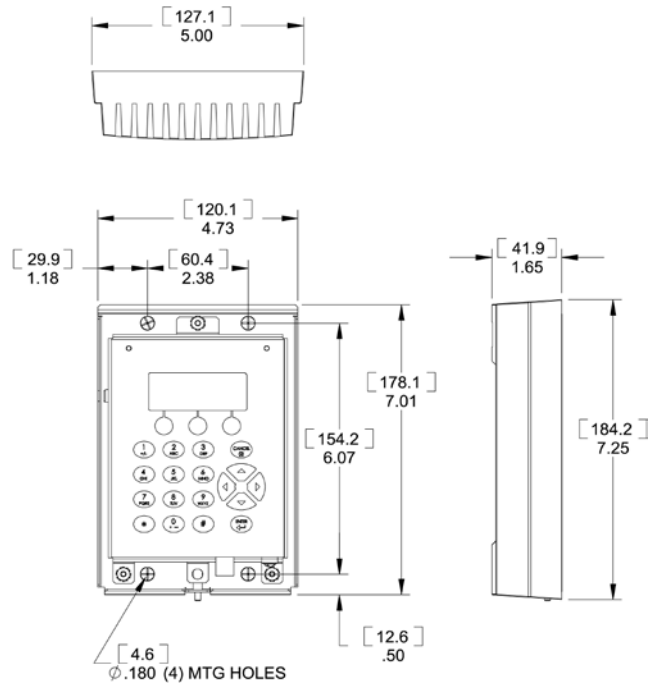

### MODELS

- xP-Display (includes 3 foot cable)
- xP-Display-10 (includes 10 foot cable)

- Power Consumption:** 70 mA
- Display Properties:** 4 lines x 16 characters, backlit
- Enclosure Type:** IP54 Rating

Copyright © 2006, TAC  
 All brand names, trademarks and registered trademarks are the property of their respective owners. Information contained within this document is subject to change without notice. All rights reserved.

SDS-XPEXPANSION-I/O-A4  
 August 2007



www.tac.com

